

SECTION B-B

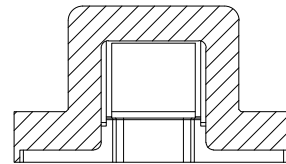

SECTION C-C

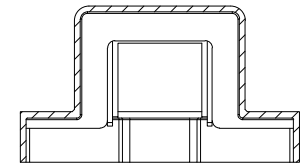

SECTION D-D

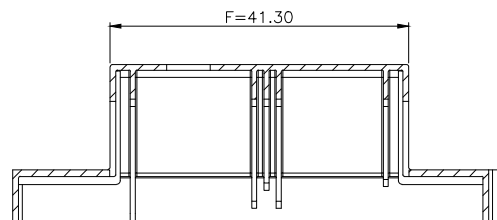
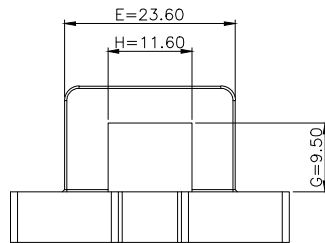
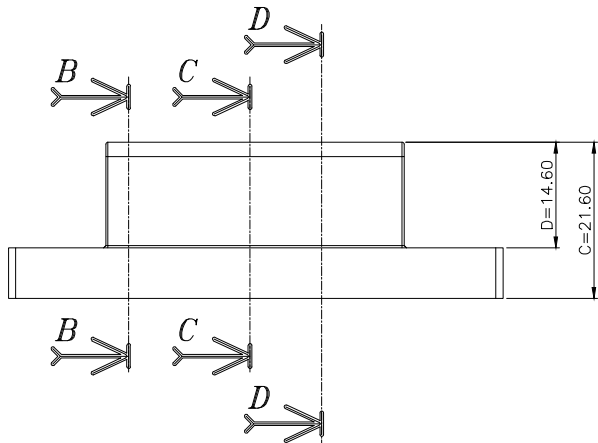

SECTION A-A

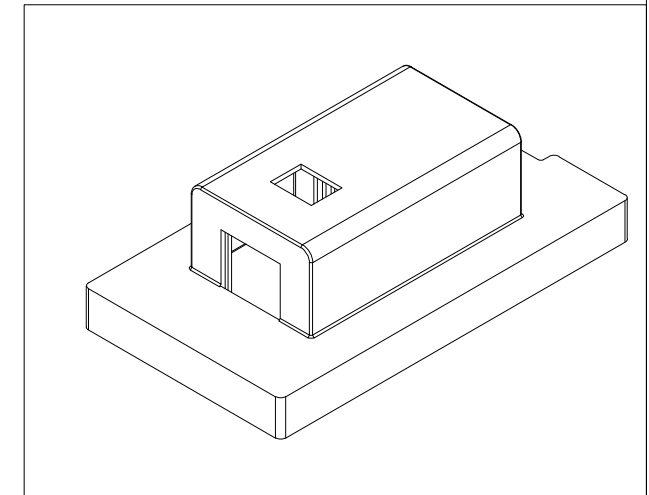
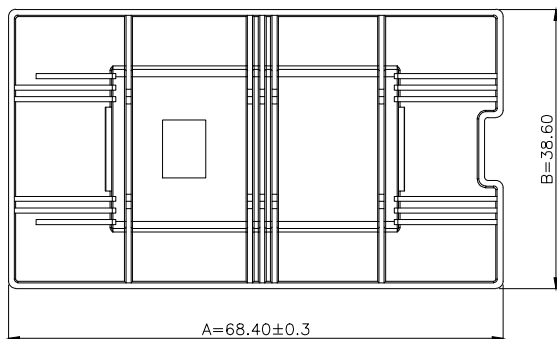

MARK				REVISION NOTE				DATE	DRAWN	CHECKED	APPROVED
△	△	△	△								
DRAWN	CHECKED	APPROVED	MATERIAL : P.E.T		UL REC. : UL94V-0	THIRD ANGLE PROJ.		SCALE : 1/1			
Deok Man, Choe	Hyoung Seok, Lee	Chul, Park			DATE : 2010.01.26	TOLERANCE : ±0.2 (Unless otherwise specified)		UNIT : m/m			
주식회사 대흥보빈 DAE HEUNG BOBBIN CO., LTD			TITLE EE 34*52 CAP				DWG NO DH-100308-2084-01				